

Turmdrehkran 42 KR.1

Tower Crane / Grue à tour / Gru a torre / Grúa torre /
Guindaste de torre / Кран башенный

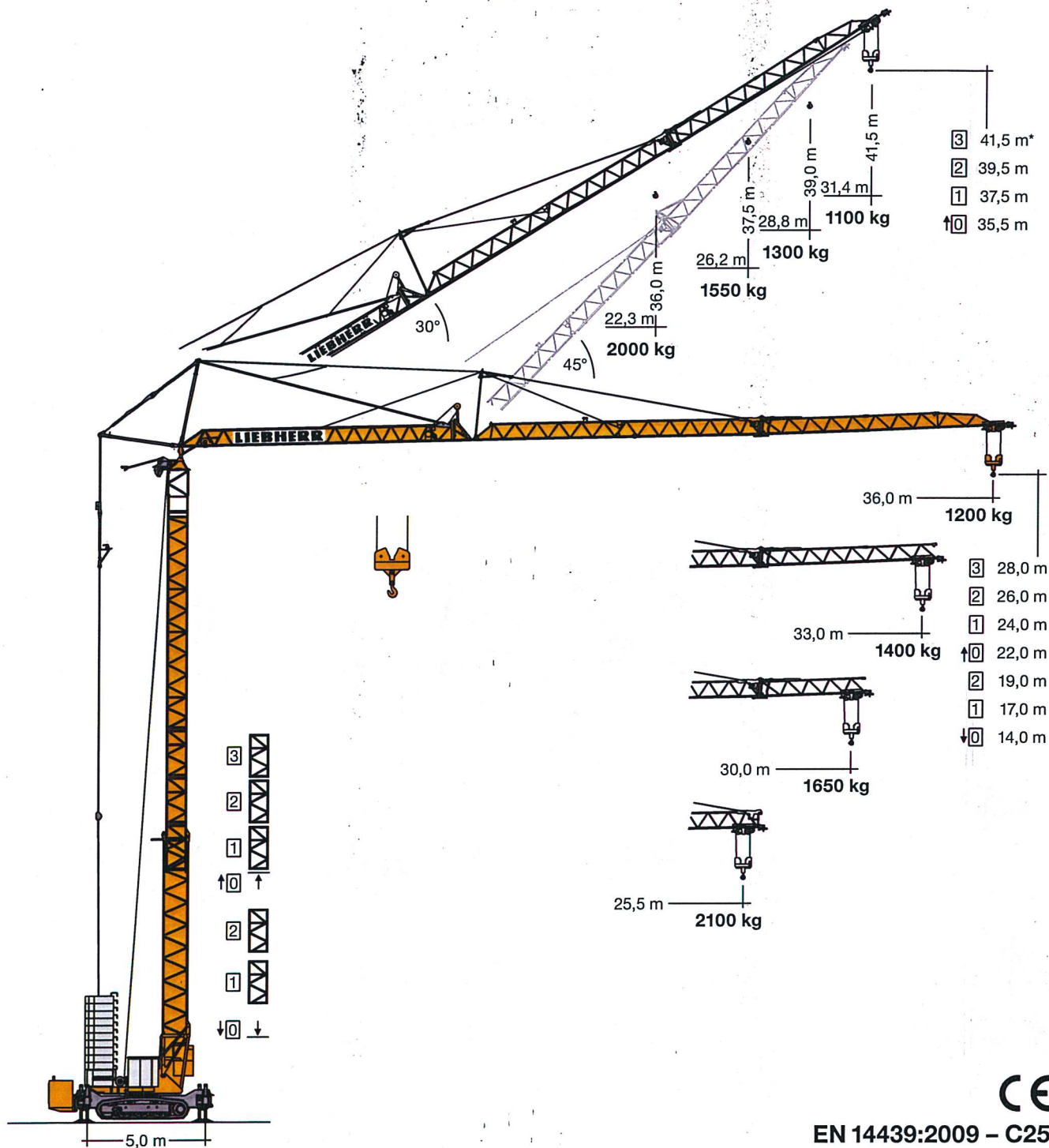



EN 14439:2009 - C25

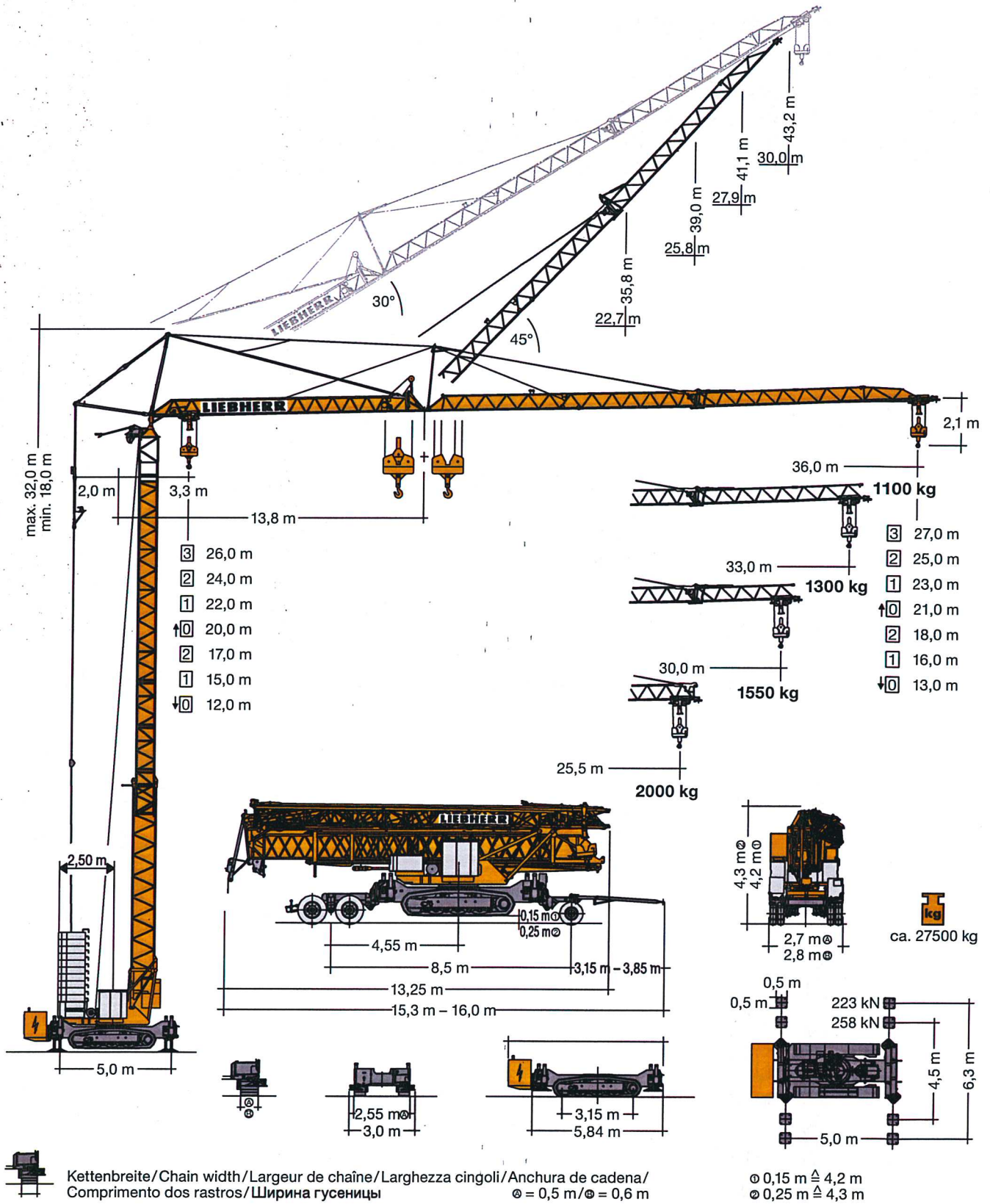

www.kammerlander-kran.com



Gewicht Weight/Poids/Peso/Peso/Pesos/Massa

	$r = 2,50 \text{ m}$	20820 kg		23020 kg (HH 26 m: + 900 kg)
---	----------------------	----------	---	---------------------------------

* siehe Betriebsanleitung./see instruction manual./voir manuel de service./vedasi le istruzioni sull'uso./según manual./ver manual de instruções./см. инструкцию по эксплуатации.

Ausladung und Tragfähigkeit





Radius and capacity/Portée et charge/Sbraccio e portata/
Alcances y cargas/Alcance e capacidade de carga/Вылет и грузоподъемность

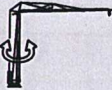
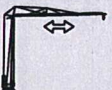

m	m/kg	m/kg																			
		16,0	18,0	20,0	21,0	22,0	23,0	24,0	25,0	25,5	26,0	27,0	28,0	29,0	30,0	31,0	32,0	33,0	34,0	35,0	36,0
36,0	3,3 – 19,40 2500	2500	2500	2410	2280	2160	2050	1950	1860	1810	1770	1690	1620	1560	1490	1440	1380	1330	1290	1240	1200
33,0	3,3 – 20,18 2500	2500	2500	2500	2390	2260	2150	2040	1950	1900	1860	1780	1700	1630	1570	1510	1450	1400			
30,0	3,3 – 21,04 2500	2500	2500	2500	2500	2370	2250	2140	2040	2000	1950	1870	1790	1720	1650						
25,5	3,3 – 21,95 2500	2500	2500	2500	2500	2490	2370	2250	2150	2100											

m	m/kg	m/kg																			
		13,0	14,0	16,0	18,0	20,0	23,0	24,0	25,0	25,5	26,0	27,0	28,0	29,0	30,0	31,0	32,0	33,0	34,0	35,0	36,0
36,0	3,3 – 22,56 2000	2000	2000	2000	2000	2000	1950	1850	1760	1720	1680	1600	1530	1460	1400	1340	1290	1230	1190	1140	1100
33,0	3,3 – 23,46 2000	2000	2000	2000	2000	2000	2000	1950	1850	1800	1760	1680	1600	1530	1470	1410	1350	1300			
30,0	3,3 – 24,45 2000	2000	2000	2000	2000	2000	2000	2000	1950	1900	1850	1770	1690	1620	1550						
25,5	3,3 – 25,50 2000	2000	2000	2000	2000	2000	2000	2000	2000	2000											

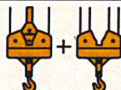
m	m/kg	m/kg																			
		13,0	14,0	16,0	18,0	20,0	23,0	24,0	25,0	25,5	26,0	27,0	28,0	29,0	30,0	31,0	32,0	33,0	34,0	35,0	36,0
36,0	3,3 – 12,77 4000	3910	3580	3040	2630	2320	1950	1850	1760	1710	1670	1600	1520	1460	1400	1340	1280	1230	1190	1140	1100
33,0	3,3 – 13,25 4000	4000	3740	3180	2760	2430	2050	1940	1850	1800	1760	1680	1600	1530	1470	1410	1350	1300			
30,0	3,3 – 13,79 4000	4000	3930	3340	2900	2550	2150	2050	1950	1900	1850	1770	1690	1620	1550						
25,5	3,3 – 14,36 4000	4000	4000	3510	3050	2690	2270	2150	2050	2000											

m	m/kg	Auslegersteilstellung 30°/Elevated jib 30°/Flèche inclinée 30°/Braccio inclinato a 30°/ Pluma inclinada 30°/Lança inclinada 30°/Положение стрелы под углом 30°																
		16,0	18,0	20,0	22,3	23,0	24,0	25,0	26,0	26,2	27,0	28,0	28,7	29,0	30,0	31,0	31,4	
36,0	3,0 – 15,91 2500	2480	2160	1900	1670	1610	1530	1450	1390	1370	1320	1270	1220	1210	1160	1120	1100	
33,0	3,0 – 16,67 2500	2500	2280	2010	1770	1700	1620	1540	1470	1460	1400	1340	1300					
30,0	3,0 – 17,51 2500	2500	2420	2140	1880	1810	1720	1640	1560	1550								
25,5	3,0 – 18,45 2500	2500	2500	2270	2000													

	0 ↔ 0,9 U/min sl./min tr./min	3,0 kW FU	
	20,0/40,0 m/min	1,3/2,3 kW	
	0 – 45° ca. 60 sec.	1,5 kW	
BGL	 C.0.03.0045	 C.0.03.0045	
	400 V – 440 V	50 Hz/60 Hz	16,0 kVA (FU)

	Stufe / Step / Cran / Marcia / Velocidad / Velocidade / Передача		
11,0 kW FU  	kg	m/min	
	1	2500	4,9
	2	2500	24,7
	3	1300	41,9
	4	1000	53,3
	1	2000 4000	4,9 2,5
	2	2000 4000	24,7 12,3
	3	1300 2600	41,9 20,9
4	1000 2000	53,3 26,6	

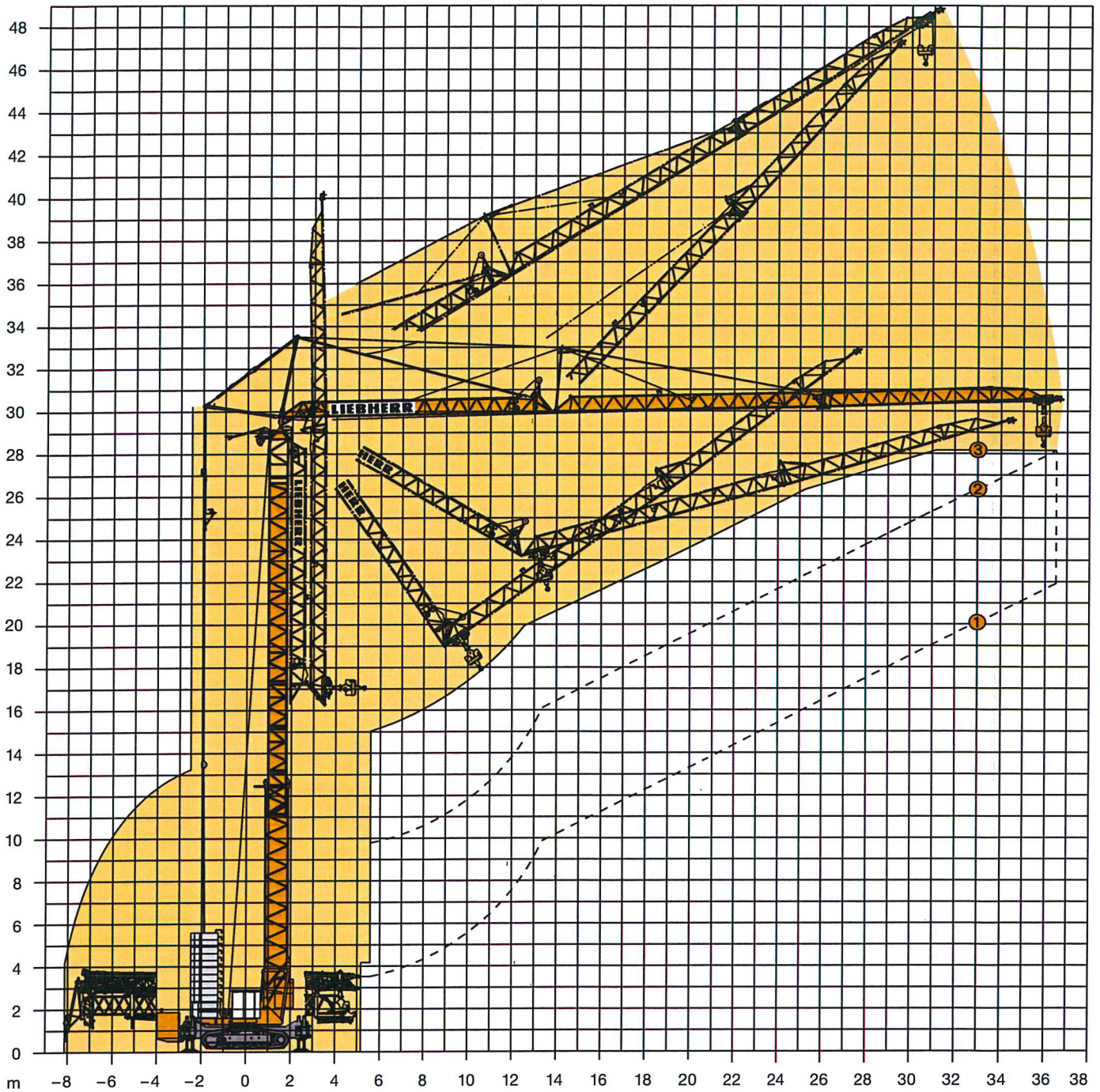

①
 ohne Turmstück
 without tower section
 sans éléments de mât
 senza elementi di torre
 sin tramo de torre
 sem tramo de torre
 без башенных секций

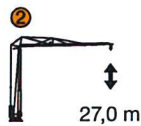

②
 3 Turmstücke
 3 tower sections
 3 éléments de mât
 3 elementi di torre
 3 tramos de torre
 3 tramos de torre
 3 башенные секции

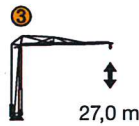











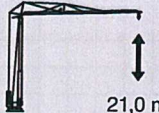
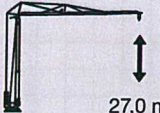
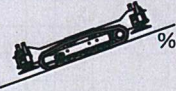

③
 3 Turmstücke
 3 tower sections
 3 éléments de mât
 3 elementi di torre
 3 tramos de torre
 3 tramos de torre
 3 башенные секции

Ausleger-Luftmontage
 Aerial mounting of the jib
 Montage de la flèche en l'air
 Montaggio aereo del braccio
 Montaje aéreo de la pluma
 Montagem aerea da lança
 Монтаж стрелы в воздухе

Geländegängigkeit

Off-road capability/Aptitude en tout terrain/Idoneità al fuoristrada/Aptitud de marcha sobre toda clase de terrenos/Capacidade de funcionamento sobre todo o tipo de terrenos/Повышенная проходимость

					
 %	30 %	25 %	15 %	10 %	7 %
 %	15 %	15 %	8 %	7 %	3 %
 max.	ca. 14 N/cm ²	ca. 25 N/cm ²	ca. 25 N/cm ²	ca. 25 N/cm ²	ca. 25 N/cm ²
$V_{\max.}$	25 m/min	10 m/min	10 m/min	10 m/min	10 m/min

					L (m)	B (m)	H (m)	kg
Pos. Item Rep. Voce Pos. Ref. Поз.	Anz. Qty. Qta. Qta. Cant. Cant. Кол-во							
1	3	Turmstück / Tower section / Élément de mât / Elemento di torre / Tramo de torre / Peça de torre / Башенная секция			2,10	0,85	0,88	350
2	1	Ausleger-Verlängerung 25,5 m – 30,0 m / Jib extension / Rallonge de la flèche / Elemento estensione braccio / Prolongación de pluma / Extensão da lança / Удлинение стрелы			4,70	0,80	0,70	235
3	1	Ausleger-Verlängerung 30,0 m – 33,0 m / Jib extension / Rallonge de la flèche / Elemento estensione braccio / Prolongación de pluma / Extensão da lança / Удлинение стрелы			3,10	0,80	0,70	90
4	1	Ausleger-Verlängerung 33,0 m – 36,0 m / Jib extension / Rallonge de la flèche / Elemento estensione braccio / Prolongación de pluma / Extensão da lança / Удлинение стрелы			3,10	0,80	0,70	70
5	1	Raupenunterwagen / Crawler undercarriage / Châssis à chenilles / Carro cingolato / Carro sobre raíles / Carro de lagarta / Опорная рама на гусеничном шасси			5,835	2,55 ⊕ 2,65 ⊕	1,46	12000
6	1	Stromgenerator mit Konsole / Current generator with bracket / Générateur de courant avec semelle / Generatore di corrente con supporto / Generador de corriente con consola / Gerador de corrente de consola / Генераторный агрегат с кронштейном		72 kVA	2,49	1,03	1,48	1350
7	1	Transportachse vorne Tra 100 KY 6A / Road transport axle front / Essieux de transport avant / Asse di trasporto anteriore / Eje delantero para transporte / Eixo de transporte dianteiro / Транспортировочная ось, передняя			3,65 – 4,15	1,45	1,10	920
8	1	Transportachse hinten Tra 204 GZ1 / Road transport axle behind / Essieux de transport arrière / Asse di trasporto posteriore / Eje trasero para transporte / Eixo de transporte traseiro / Транспортировочная ось, задняя			2,50	2,50	1,10	1900
9	1	Kiste mit Seilen und Kleinteilen / Case with ropes and small parts / Caisse avec câbles et pièces détachées / Cassa con funi e accessori / Caja con cables y piezas sueltas / Caixa contendo cabos e acessórios / Ящик с мелкими деталями и с канатами			1,00	0,80	1,00	450

Änderungen vorbehalten! / Subject to technical modifications! /
Sous réserves de modifications ! / Con riserva di modifiche! /
¡Sujeto a modificaciones sin previo aviso! / Sujeto a modificacões! /
С правом внесения изменений!

Sämtliche Angaben erfolgen ohne Gewähr. / This information is supplied without liability. /
Ces renseignements sont sans garantie. / Tutte le indicazioni fornite senza garanzia. /
Declinamos toda responsabilidad derivada de la información proporcionada. / Declinamos
qualquer responsabilidade quanto à informação fornecida. / Все данные указаны без обязательств.

120 P – 5810 • EN 14439:2009 – A3 • BGL C.0.03.0045 • 04.20

Printed in Germany.

Liebherr-Werk Biberach GmbH
Postfach 1663, D-88396 Biberach an der Riss
☎ +49 73 51 41-0, Fax: +49 73 51 41 22 25
www.liebherr.com, E-Mail: info.lbc@liebherr.com

Liebherr Industrias Metálicas, S.A.
Polígono Industrial Agustinos, calle E, E-31014 Pamplona
☎ +34 94829 70-00, Fax +34 94829 70-29
www.liebherr.com, E-Mail: info.lim@liebherr.com